



art metal

# 15 NEPTUN LED

F.P.H. Art Metal Sp.j.

Ul. Jabłoniowa 124, 83-331 Łapino Kartuskie, Poland  
Tel. 0048 58 681 80 78, Fax: 0048 58 681 80 64  
www.art-metal.pl e-mail: biuro@art-metal.pl

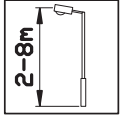

### Construction:

Luminary consists of aluminum body with LED light source inside, mounted with fastening disc. Radiator is fixed to the disc. LED module is fixed to the radiator and closed with a lens. Voltage power supply empowers the module. Luminary is tightly closed using glass shade, seal and throughout aluminum frame with bolts. Taking off top cover (9), allows access to luminary inside, from above. Handle allows fixing luminary to the arm, helping adjusting luminary angle downgrade.

### Mounting instruction:

- \*) - by tightening the radiator, fasten LED light source to the disc
- connect electricity, fasten disc to the body, if necessary take off top cover to allow access.
- fasten rings, glass and seals – tighten with bolts.

If any lantern elements are supplied factory-mounted, the mounting stages marked with \*) should be omitted (as this has already been done by the manufacturer).



### TECHNICAL DATA:

**Power:** ~230/50Hz

**Protective class:** I or II

**IP66 -electrical part**

**IP66 -optical part**

**IK08**

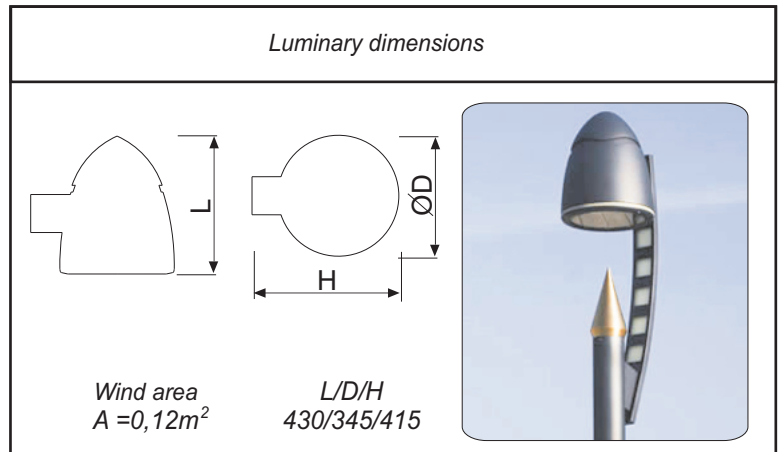

**WARNING !!** The weight of the unit may slightly differ for individual production batches.





art metal

# 15 NEPTUN LED

F.P.H. Art Metal Sp.j.

Ul. Jabłoniowa 124, 83-331 Łapino Kartuskie, Poland  
Tel. 0048 58 681 80 78, Fax: 0048 58 681 80 64  
www.art-metal.pl e-mail: biuro@art-metal.pl

## DOSTĘPNE SOCZEWKI:

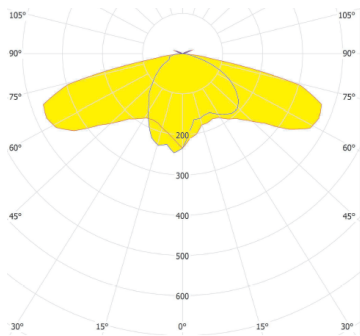

GT

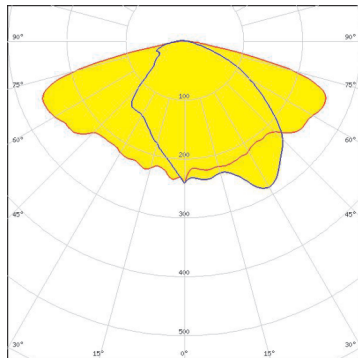

DWC2

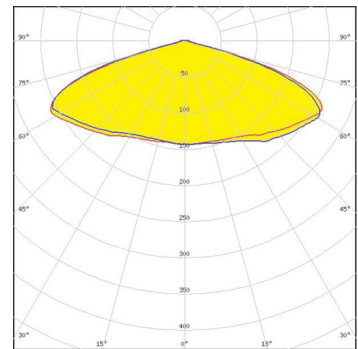

VSM

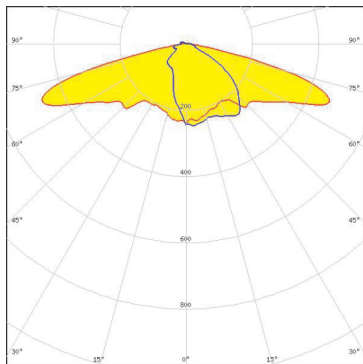

T2

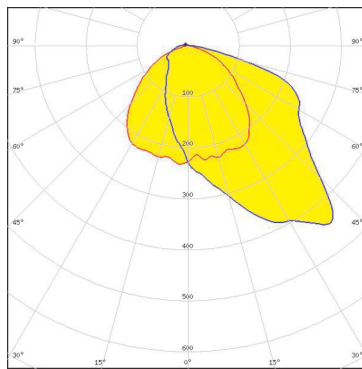

T4

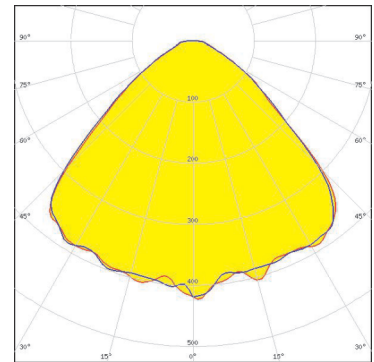

WWW

## SCHEMATY ELEKTRYCZNE:

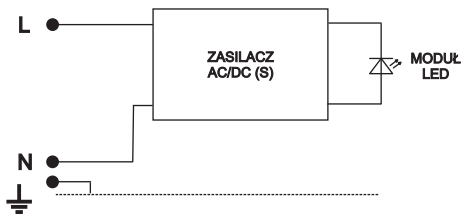

1. Źródło światła LED -zasilacz podstawowy

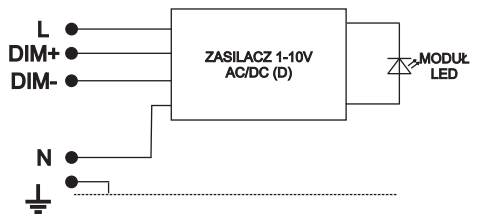

2. Źródło światła LED- zasilacz ściemniany

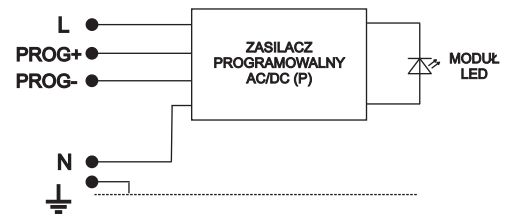

3. Źródło światła LED-zasilacz programowalny

Symbol oprawy	Typ źródła	Strumień świetlny[lm]			Typ źródła	Strumień [lm] 2200K (822)	Waga [kg]	Pn [W]
		2700K (827)	3000K (830)	4000K (840)				
15L-22W	CMA2550	2881	2990	3170	CXB2540	2051	9,7	22
15L-33W	CMA2550	4189	4286	4609	CXB2540	2982	9,7	33
15L-38W	CMA2550	4733	4842	5207	CXB2540	3369	9,7	38
15L-50W	CMA2550	5993	6131	6593	CXB2540	4266	9,7	50
15L-58W	CMA2550	6740	6896	7415	CXB2540	4797	9,7	58

**UWAGA !!** W poszczególnych seriach produkcyjnych waga oprawy może ulec niewielkim zmianom.

