



art metal

05 DAWID

F.P.H. Art Metal Sp.j.

Ul. Jabłoniowa 124, 83-331 Łapino Kartuskie, Poland
Tel. 0048 58 681 80 78, Fax: 0048 58 681 80 64
www.art-metal.pl e-mail: biuro@art-metal.pl

Construction:

The unit consists of a lamp body (1) with an in-built tray (2) holding an igniter module (3) and a lampholder (4). The tray is covered by a housing (5), to which a reflector(ODB-3) (6) can additionally be fixed. The tightness of the connection between the housing and the lamp base is provided by a gasket (8). A lamp (7) is put in the lampholder. A shade (9) is fitted to the lamp body (1).

Mounting instructions:

- *)-Mount the igniter module (3) and the lampholder (4) on the tray (2).
- Connect the electrical system of the pole to the igniter module(3).
- *)-Fix the tray (4) to the lamp body (1)
- Fix the housing (5) complete with the gasket (8) to the lamp body (1).
- Put the bulb (7) in position.
- Attach the RASTER reflector (6) to the housing (5) with the bolts.
- Screw the shade (9) all the way into the female threaded lamp body.

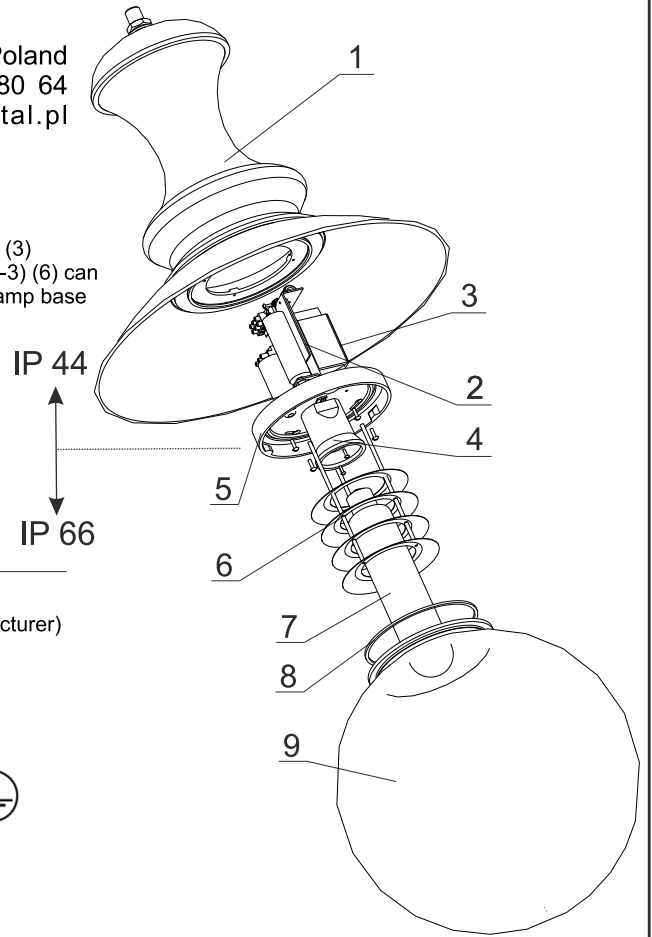

If any lantern elements are supplied factory-mounted, the mounting stages marked with *) should be omitted (as this has already been done by the manufacturer)

TECHNICAL DATA:

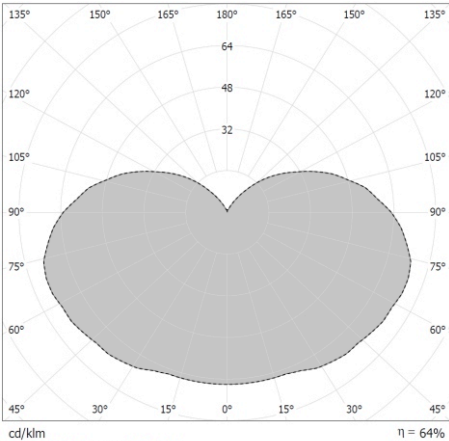

Photometry (polar plot)

Power: ~230/50Hz

Protective class: I

IP44 -electrical part

IP66 -optical part

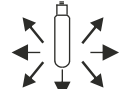
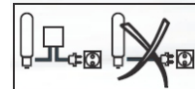

ELECTRICAL DIAGRAM:

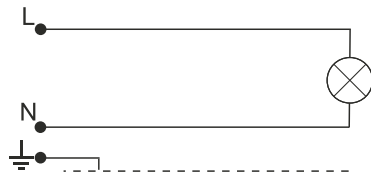

1. Incandescent bulb

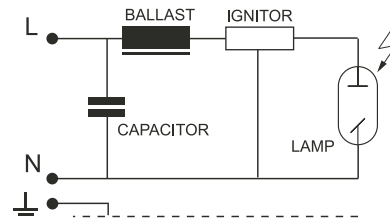

2. Sodium / metal halide lamps

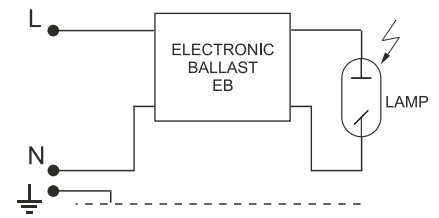

3. Sodium / metal halide lamps

Type	Light-producing element	Lamp holder	Weight [kg]	Pn [W]		Luminary dimensions
				IC	EB	
05MH-70W	MH/HSI/HPI	E27	9,3	81	75	
05MH-100W	MH/HSI/HPI	E27	9,4	114	105	
05MH-150W	MH/HSI/HPI	E27	10,1	169	155	
05S-70W	WLS/SHP/SON	E27	9,4	81	75	
05S-100W	WLS/SHP/SON	E40	9,5	114	105	
05S-150W	WLS/SHP/SON	E40	10,4	169	155	
05Z-E/Z	Bulb / MINI - LINX	E27	8,0	Maks. 60		

WARNING !! The weight of the unit may slightly differ for individual production batches.

