



art metal

19 LUMINA (ODB-10)

F.P.H. Art Metal Sp.j.

Ul. Jabłoniowa 124, 83-331 Łapino Kartuskie, Poland
Tel. 0048 58 681 80 78, Fax: 0048 58 681 80 64
www.art-metal.pl e-mail: biuro@art-metal.pl

Construcion:

The unit consists of a metal base (1) which holds a shade (2). The shade is sealed by ring gasket (3) from the bottom. A reflector ODB-10 (4) is attached to the shade. A tray (5) with an igniter module (6) and lampholder (7) are mounted on the reflector. A lamp is fitted into the lampholder (8). The metal shade (2) is closed with a decorative top cover (9). Gaskets (10) make the unit weather-tight. A lyre-shaped mounting holder mounted on the base from the bottom is used to attach the unit to a pole or a bracket.

Mounting instruction:

- *) -Put the shade (2) into the base (1), keeping it tight against the frame with the gaskets (3).
- *) -Attach the tray (5) with the igniter (6) and the lampholder (7) to the reflector (4).
- Attach the reflector (4) and the decorative top cover (9) to the shade (1).
- Put the lamp (9) in position.
- Connect the electrical cables to the terminals of igniter (6).

If any lantern elements are supplied factory-mounted, the mounting stages marked with *) should be omitted (as this has already been done by the manufacturer)

TECHNICAL DATA:

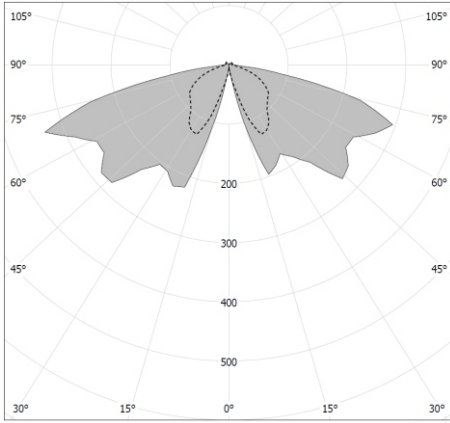

Power: ~230/50Hz

Protective class: I

IP65 - electrical part

IP65 - optical part

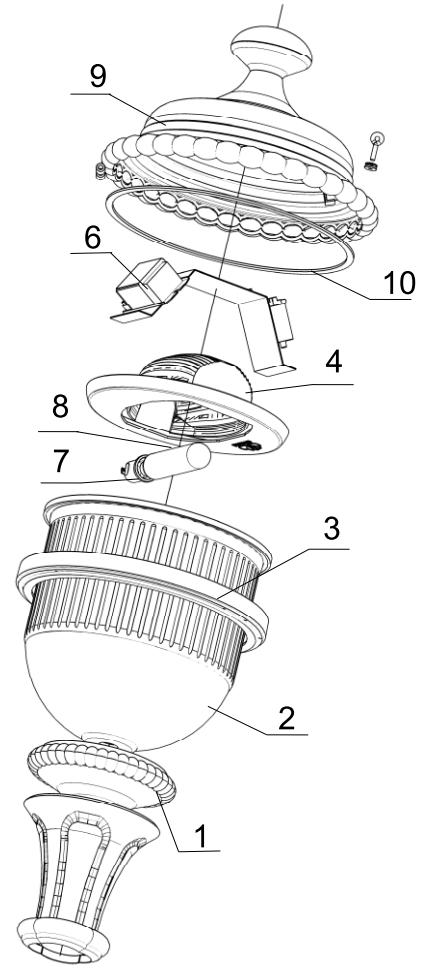
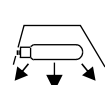
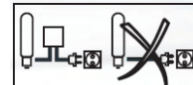
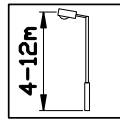

ELECTRICAL DIAGRAM:

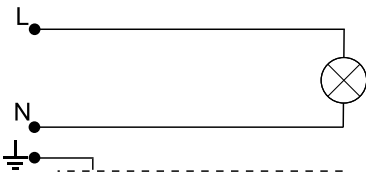

1. Incandescent bulb

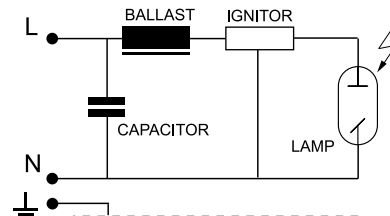

2. Sodium / metal halide lamps

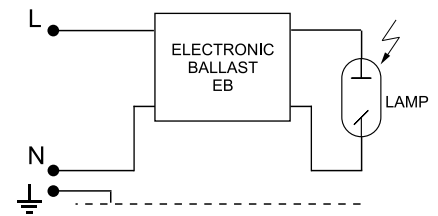

3. Sodium / metal halide lamps

Type	Light-producing element	Lamp holder	Weight [kg]	Pn [W]		Luminary dimensions
				IC	EB	
19MH-70W	MH/HSI/HPI	E27	12,9	81	78	<p>Wind area A = 0,22m²</p> <p>H/D 900/460</p>
19MH-100W	MH/HSI/HPI	E27	13,0	114	109	
19MH-150W	MH/HSI/HPI	E27	13,8	169	164	
19S-70W	WLS/SHP/SON	E27	13,1	81	78	
19S-100W	WLS/SHP/SON	E40	13,2	114	109	
19S-150W	WLS/SHP/SON	E40	13,9	169	164	
19Z-E/Z	Bulb / MINI - LINX	E27	11,6	Max. 60		

WARNING !! The weight of the unit may slightly differ for individual production batches.

