



art metal

F.P.H. Art Metal Sp.j.

Ul. Jabłoniowa 124, 83-331 Łapino Kartuskie, Poland
Tel. 0048 58 681 80 78, Fax: 0048 58 681 80 64
www.art-metal.pl e-mail: biuro@art-metal.pl

27 SYNCHRO II (ODB-10)

Construction:

The luminary consists of a body (1) closed on the top with a bonnet (2) with hinge.

Tools are not necessary; to open the luminary, unfasten buckles (9). The body is mounted to the pole with adjustable joint (3) which enables to regulate its position. The reflector (4) is mounted to the bonnet (2) in an optical part of the luminary. Light source is available after opening the bonnet (2). Light source (7) is mounted in a ceramic lamp holder (6). Ignitor (7) is placed in a separate, hermetic compartment. The luminary is tightly closed by shade (8).

Sposób montażu:

- Oprawę zamocować na słupie lub wysięgniku wprowadzając uprzednio przewód z przegubu.
- Dokręcić dociski śrubowe, blokując oprawę w pożądanej pozycji względem drogi.
- Wykonać podłączenia elektryczne zgodnie z oznaczeniami, dokręcić dławnicę naprzewodzie zasilającym.
- Zamknąć pokrywę(2), spiąć z korpusem(1) klamrami(9).
- Nachylenie oprawy regulować korzystając z podziałki na przegubie. Właściwą pozycję należy zablokować, dokręcając śruby.

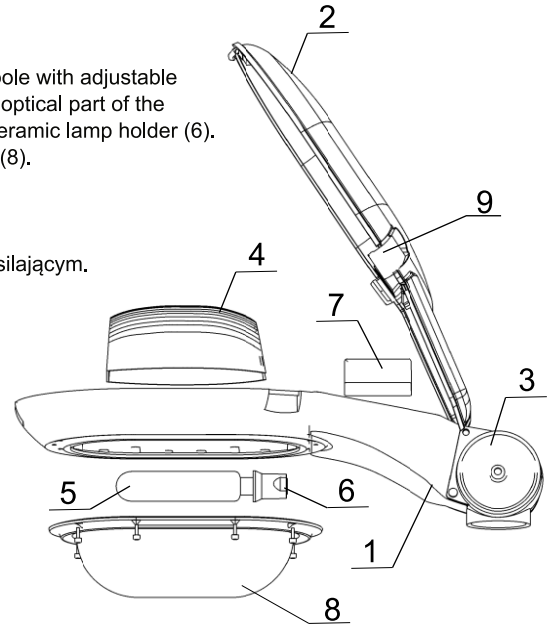

If any lantern elements are supplied factory-mounted, the mounting stages marked with * should be omitted (as this has already been done by the manufacturer)

TECHNICAL DATA:

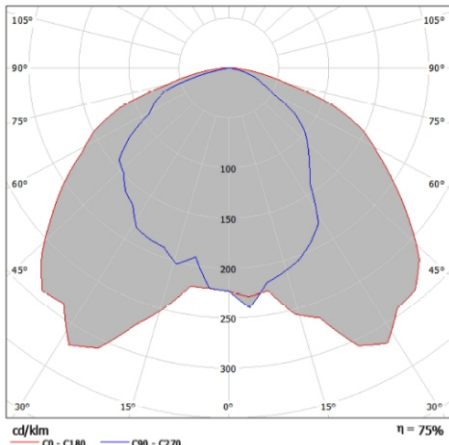

Photometry (polar plot)

Power: ~230/50Hz

Protective class: I

IP66 -electrical part

IP66 -optical part

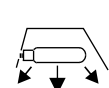
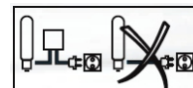
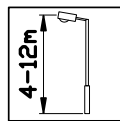

ELECTRICAL DIAGRAM:

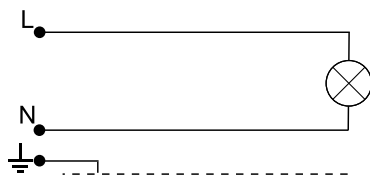

1. Incandescent bulb

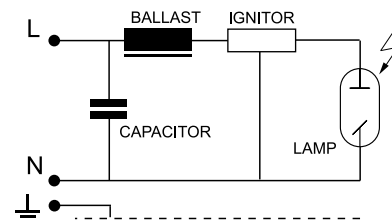

2. Sodium / metal halide lamps

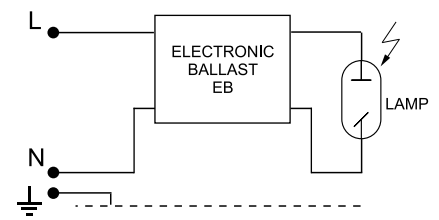

3. Sodium / metal halide lamps

Type	Light-producing element	Lamp holder	Weight [kg]	Pn [W]		Luminary dimensions
				IC	EB	
27MH-70W	MH/HSI/HPI	E27	7,9	81	78	 Wind area $A = 0,09m^2$ L/D/H 740/340/225
27MH-100W	MH/HSI/HPI	E27	8,3	114	109	
27MH-150W	MH/HSI/HPI	E27	9,2	169	164	
27S-70W	WLS/SHP/SON	E27	7,9	81	78	
27S-100W	WLS/SHP/SON	E40	8,4	114	109	
27S-150W	WLS/SHP/SON	E40	9,3	169	164	
27Z-E/Z	Bulb / MINI - LINX	E27	7,4	Max. 60		

WARNING !! The weight of the unit may slightly differ for individual production batches.

