



art metal

01 VERA

F.P.H. Art Metal Sp.j.

Ul. Jabłoniowa 124, 83-331 Łapino Kartuskie, Poland
Tel. 0048 58 681 80 78, Fax: 0048 58 681 80 64
www.art-metal.pl e-mail: biuro@art-metal.pl

Construction:

The unit consists of a metal basket (1) which holds a shade (2). The shade is sealed by ring gaskets (3) from the top and bottom. An upper reflector (4) is attached to the basket. A tray (5) with an igniter module (6) and a lampholder (7) are mounted on the upper reflector (4). A RASTER (ODB-3) reflector (8) can be mounted optionally. A bulb (9) is fitted into the lampholder. The metal basket (1) is closed with a decorative top cover (10). Gaskets (12) make the unit weather-tight. A lyre-shaped mounting holder (11) mounted on the basket from the bottom is used to attach the unit to a pole or bracket.

Mounting instructions:

- *)- Put the shade (2) into the basket (1), keeping it tight against the frame with the gaskets (3).
- *)- Attach the tray (5) with the igniter (6) and the lampholder (7) to the reflector (4).
- *)- Attach the upper reflector (4) and the decorative top cover (10) to the basket (1).
- Put the bulb (9) in position.
- Mount the RASTER reflector (8) on the unit.
- Connect the electrical cables to the terminals of the igniter (6).
- Mount the unit on a pole and tighten the bolts.

If any lantern elements are supplied factory-mounted, the mounting stages marked with *) should be omitted (as this has already been done by the manufacturer)

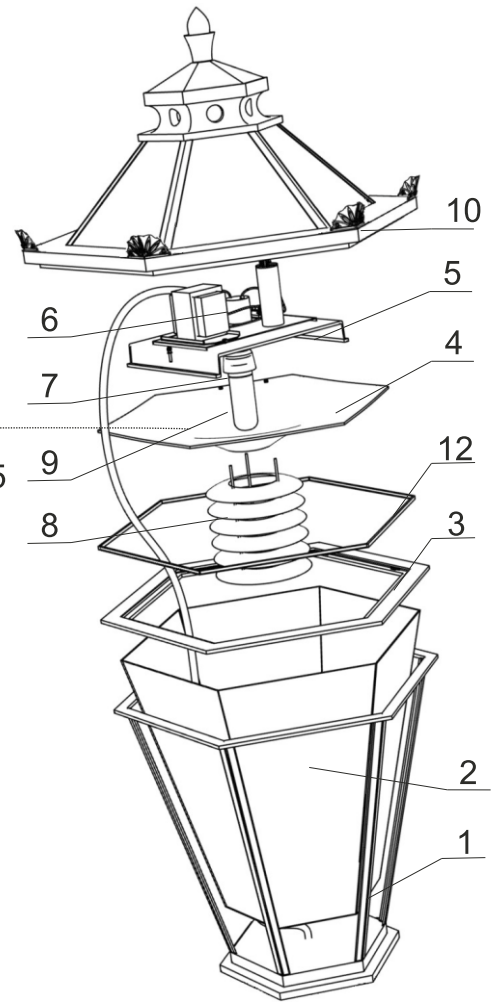

TECHNICAL DATA:

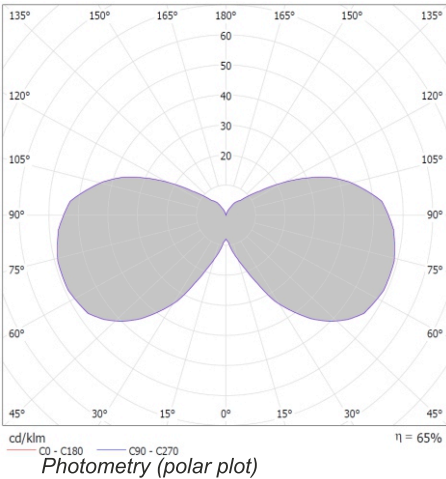

Power: ~230/50Hz

Protective class: I

IP44 - electrical part

IP65 - optical part

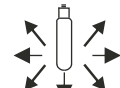
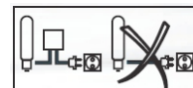

ELECTRICAL DIAGRAM:

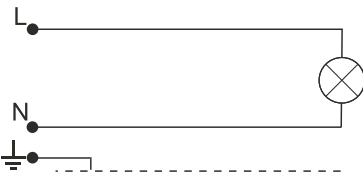

1. Incandescent bulb

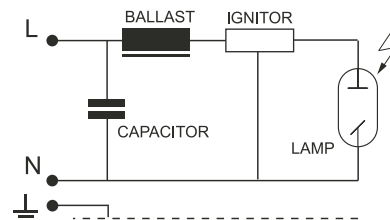

2. Sodium / metal halide lamps

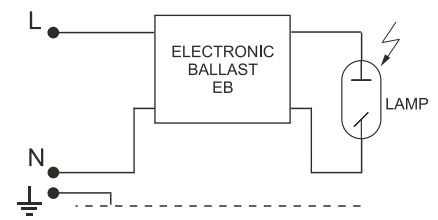

3. Sodium / metal halide lamps

Type	Light-producing element	Lamp holder	Weight [kg]	Pn [W]		Luminary dimensions
				IC	EB	
01MH-70W	MH/HSI/HPI	E27	13,2	81	75	<p>Wind area A = 0,27m²</p> <p>L/H/B 740/530/460</p>
01MH-100W	MH/HSI/HPI	E27	13,7	114	105	
01MH-150W	MH/HSI/HPI	E27	14,4	169	155	
01S-70W	WLS/SHP/SON	E27	13,2	81	75	
01S-100W	WLS/SHP/SON	E40	13,7	114	105	
01S-150W	WLS/SHP/SON	E40	14,4	169	155	
01Z-E/Z	Bulb / MINI-LINX	E27	11,7	Maks. 60		

WARNING !! The weight of the unit may slightly differ for individual production batches.

Sign:L-0001-01-04

Last revision: 2016.01.27

